

# DANPAL<sup>®</sup> LOUVRE SYSTEM

## DANPA SHADE

Translucent  
Shading System

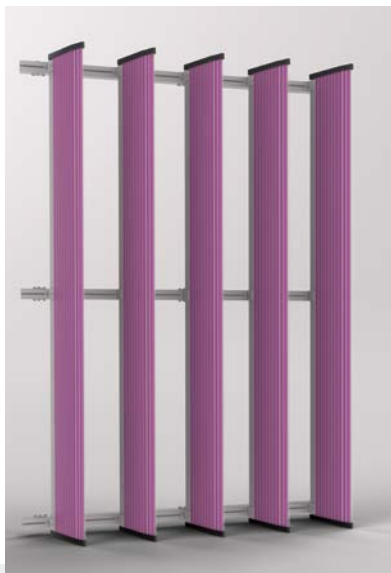

SHADING



# MAXIMUM CONTROL OVER LIGHT AND HEAT

DANPAL® LOUVRE IS A TRANSLUCENT SHADING SYSTEM THAT PROVIDES MAXIMUM CONTROL OVER LIGHT AND HEAT WITH COMPLETE UV PROTECTION. AVAILABLE IN A WIDE VARIETY OF COLOURS, FINISHES AND EFFECTS, IT PROVIDES BOTH VISUAL AND CLIMATIC BENEFITS TO NEW OR REFURBISHED BUILDINGS.

## Play with light, shade and colour

Users can adjust the louvres to create their desired balance of light and shade, achieving the right atmosphere.

The Danpal® Louvre translucent shading system can be installed on various types of building envelopes in a variety of colour combinations and finishes - stretching your imagination to the limit.

## All-weather design

It is suitable in all weather conditions and compliant with all building code requirements

Made with Microcell technology, the latest and most advanced system for architectural shading applications, Danpal® Louvre Systems offer high impact resistance. The system contains snap-on interlocking dry-glazed connectors made of aluminium - providing simple and low cost installation.



## WIDE VARIETY OF COLOURS AND FINISHES

# SUPERIOR LIGHT AND VISUAL APPEARANCE

THE PANEL'S UNIQUE STRUCTURE TRANSMITS AN EVEN DIFFUSION OF NATURAL LIGHT, PRODUCING A RICH LOOK

Specifically designed for architectural daylight applications, the tight spacing between the ribs produces a superior quality of light and an aesthetically appealing presence. Customers can select various colours and light transmission levels, with either a glossy or matt surface finish.

## High Resistance

The system provides a double tooth grip-lock connection that ensures extended longevity even when subject to high wind loads.

## Extended UV Protection

Danpal® panels offer co-extruded UV protection - resulting in longer system life.



City Service Center, Banpo, 3 District in South Korea | Danpal® Louvre System

TO SPARK YOUR IMAGINATION

# DANPA SHADE

## AURA SYSTEM

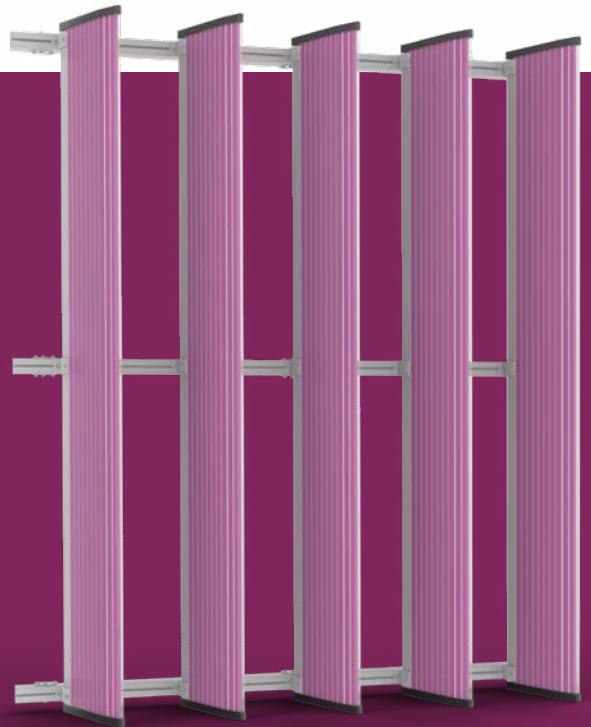
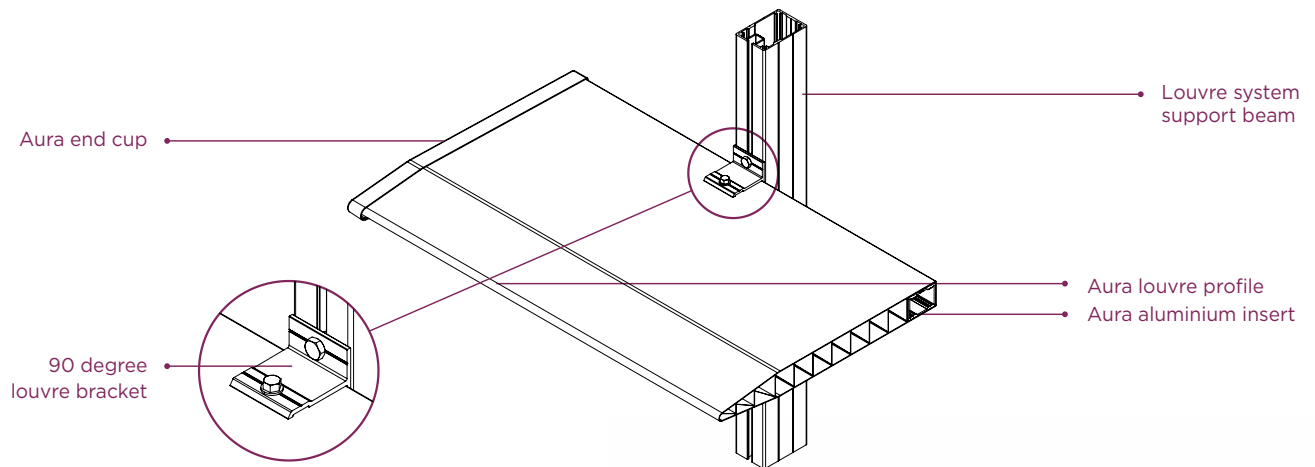

### SYSTEM BENEFITS

- Unique 3D KINETIC internal structure
- Dual internal colour options
- Vertical or horizontal installation
- Variable light transmission & shading
- Featherweight rated install

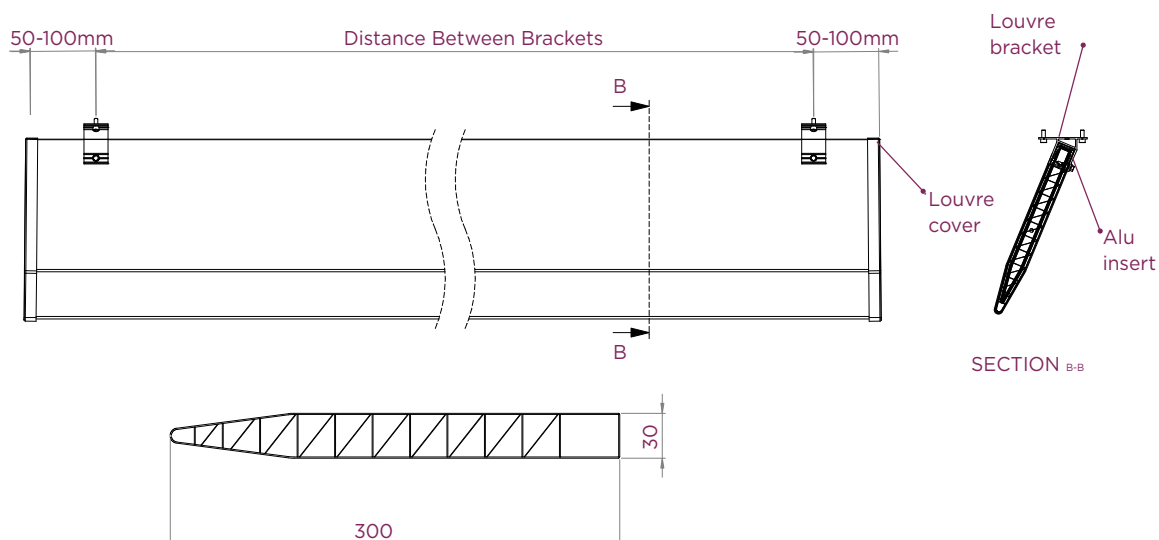

# TECHNICAL INFORMATION

## DIMENSIONS

WIDTH [mm]	THICKNESS [mm]	WEIGHT [g\m]	WEIGHT [g\m <sup>2</sup> ]*	PITCH OPTIONS	MAX LENGTH
300	30	1,780	8,200	22.5°, 45°, 90°	6 meter

\* 3 Louvres per 1 meter

## PROPERTIES

FEATURE	VALUE	
Reaction to Fire	B-s1,d0	EN 13501-1
Wind Load resistance (Test method: EN 13659)	up to 3000 mm	Class 6 (112 Km/h)
Distance between brackets	up to 3000 mm	
Distance from Louvre bracket and end of Louvre	50-150 mm *	

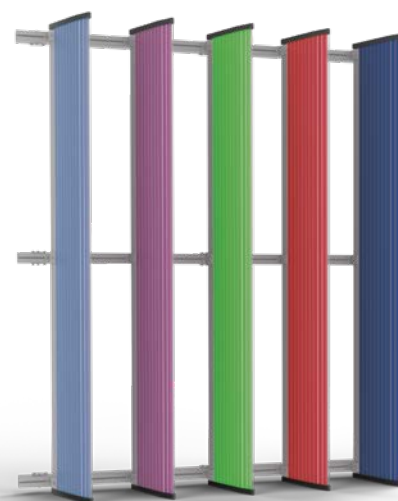

\* Final distances can be adjusted

## COLOUR WITH SHADE

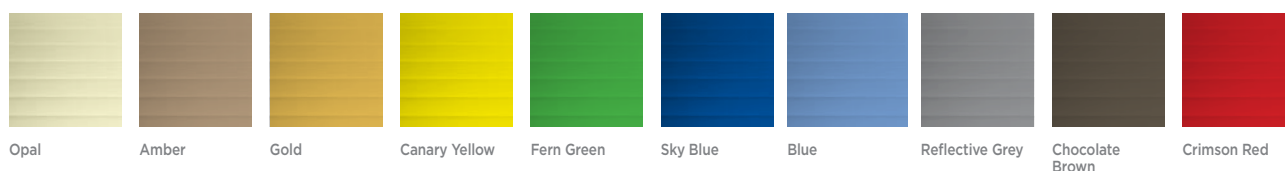

DANPA SHADE

# UMBRA SYSTEM

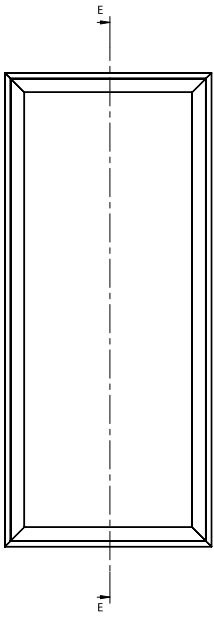

DP PANEL 16 MM THICKNESS WITH ALUMINIUM FRAME

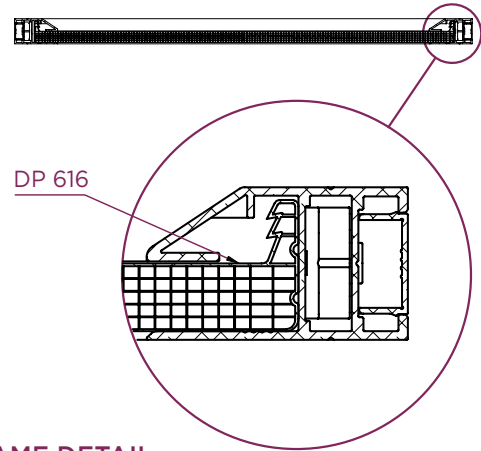

FRAME DETAIL

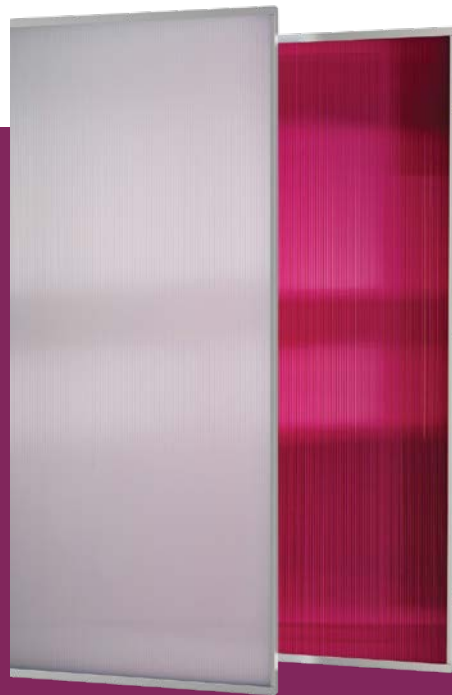

## SYSTEM BENEFITS

- Lightweight
- Wide range of colours and finishes
- Quick, easy and cost effective installation
- Recyclable materials
- Fully adjustable and compatible with building automation systems



# TECHNICAL INFORMATION

## TECHNICAL FEATURES

MODULE	616, 3DLITE, KINETIC	STANDARD
Reaction to fire	B-s1,d0	Norm NF EN 13501-1 : 2002 PV LNE M071009 - DE/5 ; DE/9
Acoustic	As per panel characteristics	CSTB : AC08-26013441/1 et AC08-2613441/2.
Light transmission	As per panel characteristics	norm ASHRAE- 74-1988.
10 year warranty	Yes	
Impact and shock resistance	Pass	PV CSTB GM 89/10 , PV CSTB GM 94/2
Finishes of panel	Low E, softlite, HP	

## LET OUR COLOURS INSPIRE YOU

### SHADES OF WHITE



Clear Ice Opal

### METALLIC

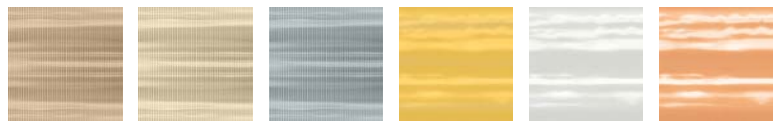

Amber Bronze Reflective Grey Gold Metallic Ice Copper

### COLOURFUL

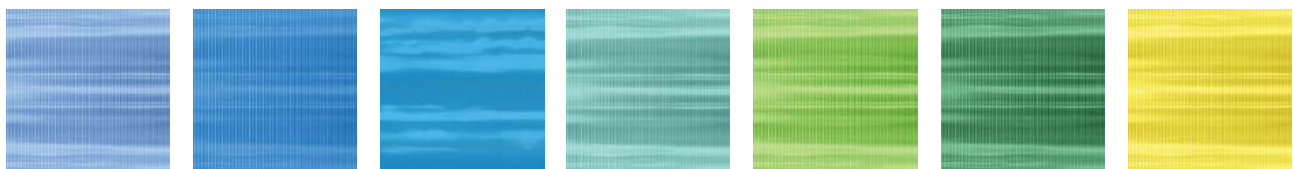

Blue Sapphire Blue Blue Arctique Green Lime Green Empire Green Yellow

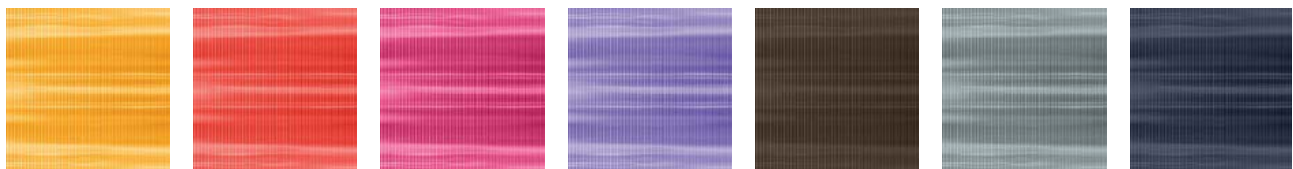

Orange Red Magenta Purple Brown Grey Black

### KINETIC

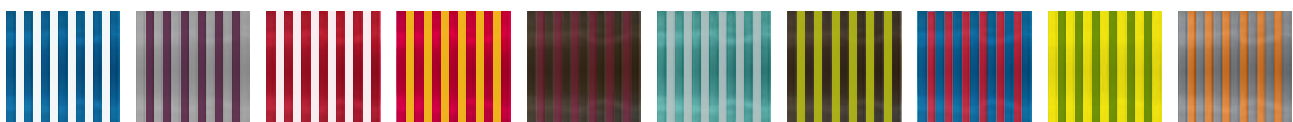

White | Sky Blue Violet Purple | Mist Grey White | Crimson Red Canary Yellow | Magenta Violet Purple | Chocolate Brown Dove Grey | Turquoise Citrus Green | Chocolate Brown Crimson Red | Sky Blue Fern Green | Canary Yellow Signal Orange | Thunder Grey

### 3DLITE

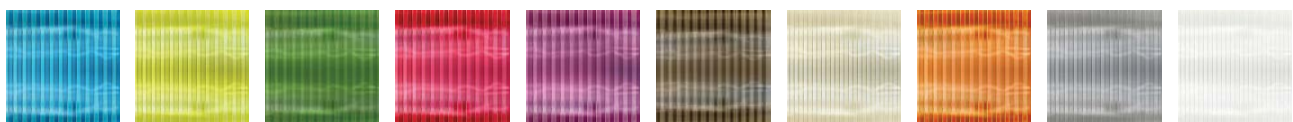

Sky Blue Citrus Green Fern Green Crimson Red Violet Purple Chocolate Brown Ivory Signal Orange Thunder Grey White

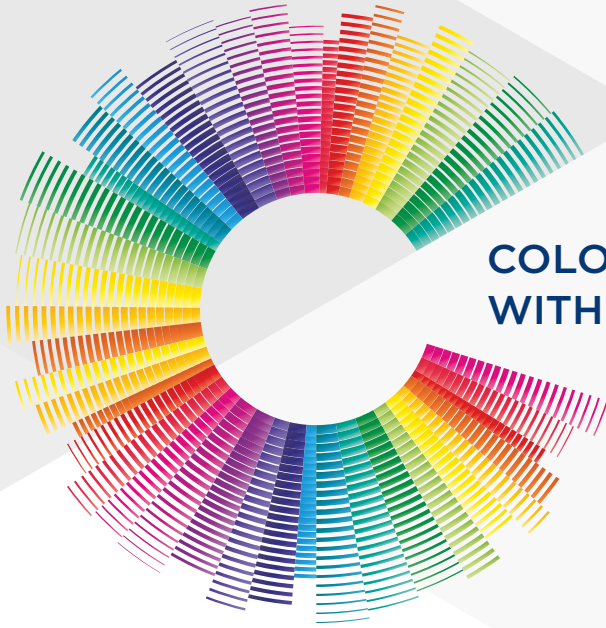

## COLOUR YOUR ATMOSPHERE WITH THE DANPAL® PALETTE

### ABOUT THE COMPANY

#### Innovative light architecture systems for building envelopes

Danpal® are creators of exceptional light-transmitting architectural systems for building envelopes, providing optimal solar and thermal comfort.

For 50 years, our innovative systems have helped architects to transform light (both natural and artificial) into a powerful and versatile tool, for architectural creations that are internally and externally radiant.

An industry visionary, Danpal® are originators of the Danpalon® translucent panel standing seam system - a light architecture solution used around the world in commercial, education, transport, health, sports and high-tech projects.

Today, the company offers complete systems - providing total solutions for the building envelope. Danpal® designs, manufactures and distributes an unmatched range of daylighting systems for all types of building requirements - from Façades, cladding, roofs, Skylight, shading, to interior and outdoor applications.

Danpal® systems are built around innovative technologies, deep architectural know-how and the ever evolving needs of our clients. Operating in five continents, Danpal® inspires architectural creativity with its rainbow of light architecture solutions.

#### Danpal® Louvre is an integral part of Danpal's range of systems - giving you a complete solution



FAÇADE



CLADDING



SKYLIGHT



OUTDOOR



SHADING



INTERIOR