





CONTROLITE®

Intelligent Daylighting System

-  FAÇADE
-  SKYLIGHT



INTELLIGENT DAYLIGHTING SYSTEM



COMFORT. CONVENIENCE. CONTROL.



CONTROLITE® FEATURES A TRANSLUCENT GLAZING PANEL WITH INTEGRATED, ROTATING LOUVRES THAT ADJUST THEIR POSITION THROUGHOUT THE DAY TO OPTIMISE DAYLIGHT TRANSMISSION LEVELS. THIS ADVANCED SYSTEM ENABLES COMPLETE CONTROL OF THE DESIRED INDOOR LIGHT INTENSITY — ANY TIME OF DAY, ANY TIME OF YEAR.

COMPLETE CONTROL OF LIGHT AT ALL TIMES

Maximises daylight in winter, blocks solar heat in summer

Controlite® delivers optimal comfort by controlling daylight transmission and solar heat gain. Its panels enable larger skylights in commercial and public buildings, optimising light and heat - whatever the season.

Increases comfort through “optimised” daylight

The Controlite® system adapts to changing light conditions throughout the day for effective control of indoor light, shade and solar heat gain.

Reduces energy consumption

The Controlite® system significantly reduces energy use from air-conditioning, heating, and artificial lighting.

Integrates sustainable design

Controlite® panels integrate into energy-efficient building design, allowing designers to earn credit points with green building rating systems.

HOW IT WORKS

An external sensor detects the direction of the sun and internal sensors register the level of light inside the building. The intelligent system then balances light levels, heat gain and shading to transmit appropriately filtered light, ensuring a comfortable indoor environment.

Daylight intelligence, creating the ideal balance of light

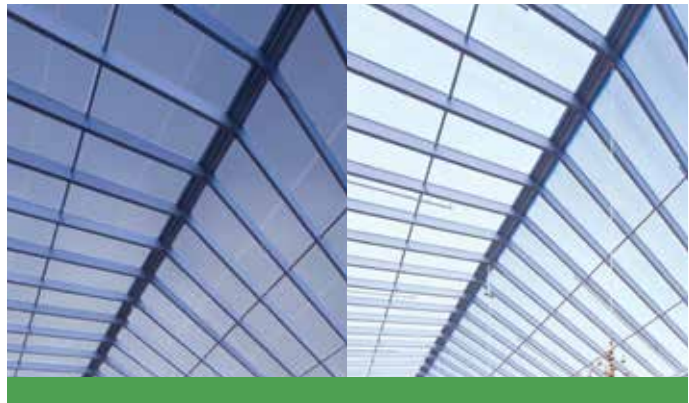

Fully closed

Fully opened

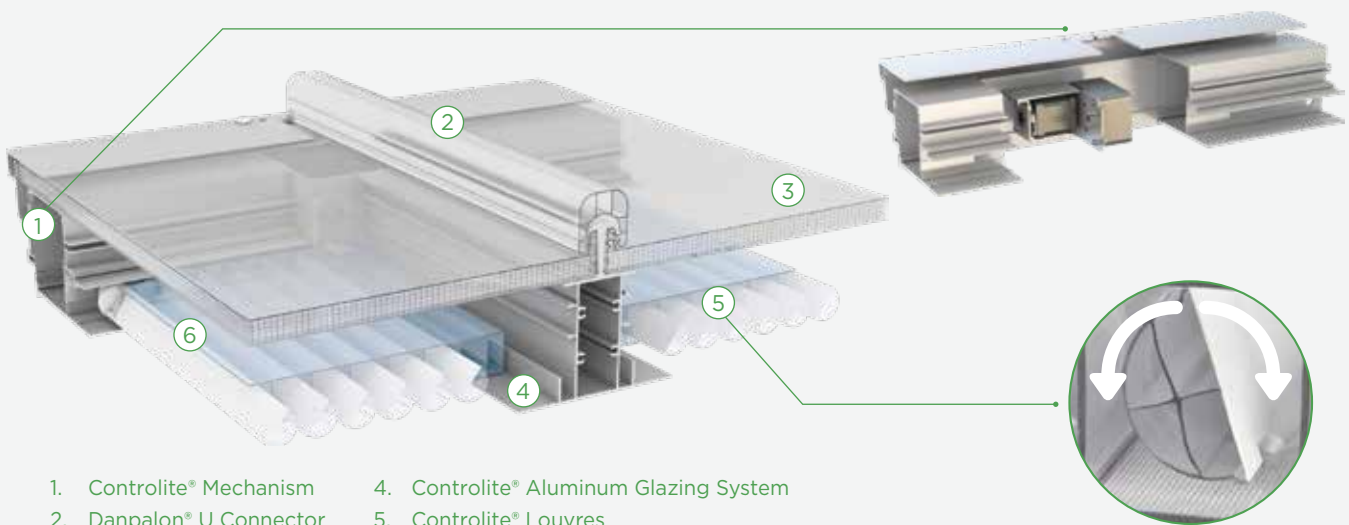

- 1. Controlite® Mechanism
- 2. Danpalon® U Connector
- 3. 16mm Danpalon® Panel
- 4. Controlite® Aluminum Glazing System
- 5. Controlite® Louvres
- 6. 30mm Twinwall Danpalon® Panel

CONTROLITE® COMPARED TO TRADITIONAL GLAZING — SUMMER

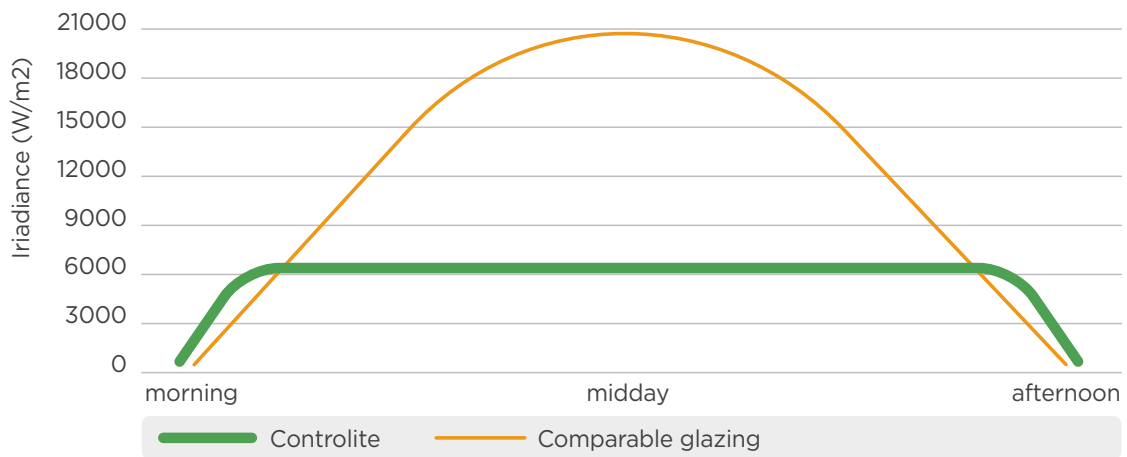

Controlite® blocks 80% of solar heat gain (W/m2).

OPTIMIZING DAYLIGHT

Traditional glazing surfaces reflect the low angle light in the morning, afternoon, and winter. They also introduce too much solar radiation at noon, when the angle of incidence is high. **The Controlite® panel optimises sunlight by adjusting the position of the louvres to suit the angle of the sun's rays if necessary.**

- Low angle of incidence (morning, afternoon, winter): The Controlite® system sets the position of the louvres to transmit the maximum amount of daylight.
- High angle of incidence (noon): The opaque face of the louvres reflect solar radiation to achieve the perfect balance of light and comfort, reducing heat gain and saving energy costs.

Balanced daylighting - light and comfort in perfect harmony

LIGHT OPTIMISATION WITH THE CONTROLITE® SOLUTION

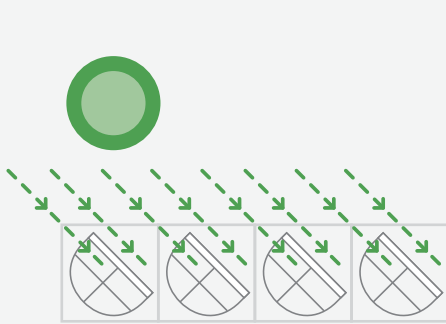

Early morning or late afternoon

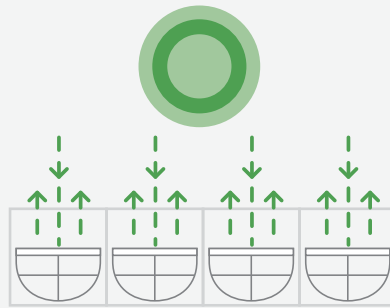

Summer midday

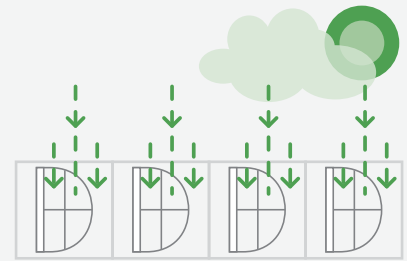

Cloudy days



37%
of visible daylight is transmitted
through Controlite® panels in the
OPEN position

5%
of visible daylight is transmitted
through Controlite® panels in the
CLOSED position

SYSTEM BENEFITS

- Provides optimal comfort in changing daylight conditions
- Offers skylighting surfaces in larger areas
- Withstands weather and temperature extremes
- Saves energy, sustainable design, reduces heating/cooling costs

CONTROLITE® FOR ROOFING

- Double glazing - Controlite® on interior, Danpalon® 16mm, 1040mm on the exterior
- Module of installation: 1049mm
- Higher thermal insulation
- Free thermal expansion
- Easy maintenance



Design Museum, Israel
Architect: Ron Arad

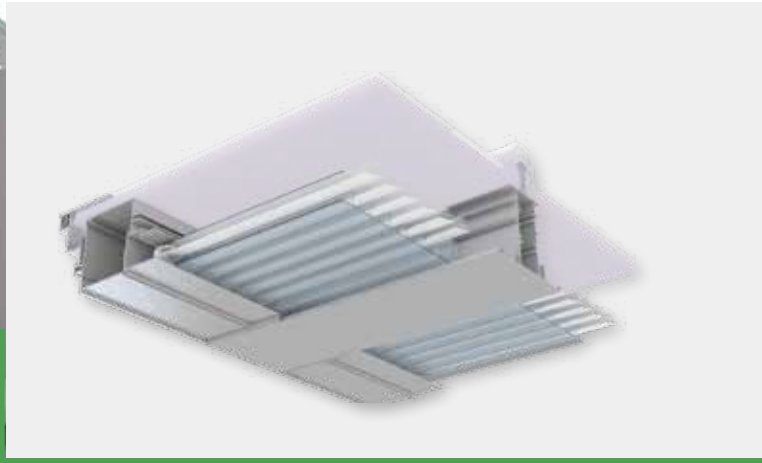
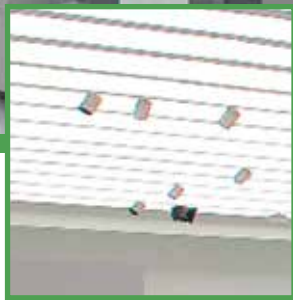

CONTROLITE® FOR FAÇADES

- Double glazing: Controlite® inside, Danpalon® 16mm, 1040mm on the exterior
- Module of installation: 1041mm
- High thermal insulation
- No visible aluminium connections on the outside
- Free expansion of the polycarbonate
- Mechanisms are easy to access and maintain



Sports Hall, France
Architect: Gremillet

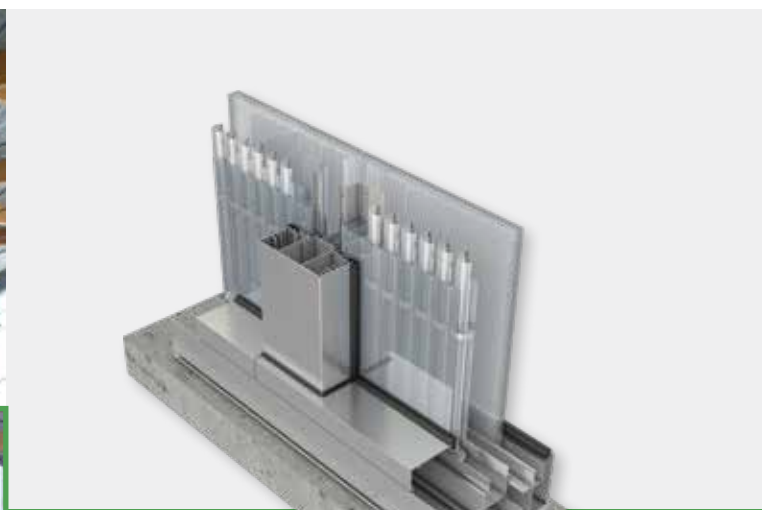

INTERNAL SOLAR AND THERMAL SIMULATION

Danpal's Smart Energy Simulator predicts and plans the amount of daylight. Using climatic data averages for the location of a given project, Danpal's Smart Energy Simulator can model the way in which Controlite® will adapt to changing weather conditions (allowing internal daylight levels and building energy consumption to be accurately predicted). This enables the energy cost saving and environmental benefits of using Controlite® to be quantified early in the design process.

- Dynamic internal daylight map simulation
- Dynamic internal energy consumption simulation

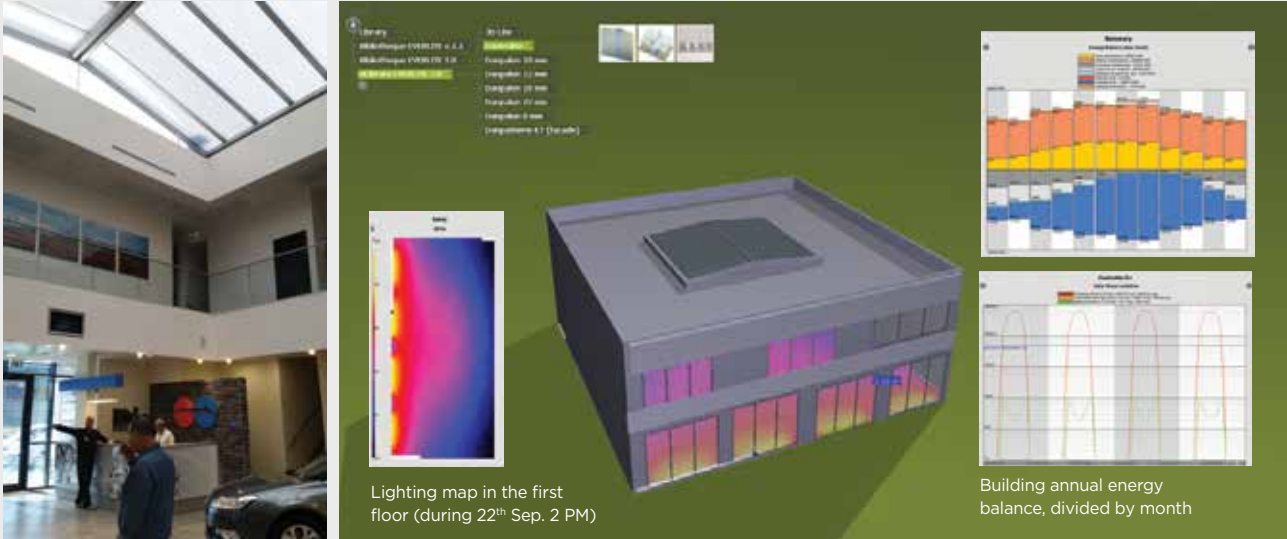

Car Dealership, Israel

OPTICAL AND THERMAL PROPERTIES

| | CONTROLITE® ROOFING SYSTEM | | CONTROLITE® FAÇADE SYSTEM | | LABORATORY /COMPANY | TEST STANDARD |
|--|----------------------------|-------|---------------------------|-------|---------------------|-------------------------|
| | open | close | open | close | | |
| Assembly module (mm) | 1049 | | 1042 | | | |
| Minimum pitch | 5° | | N/A | | | |
| Weight inc. frame (kg/m ²) | 14.5 | | 14.5 | | | |
| Uvalue (W/m ² K) | 1.0 | 0.9 | 1.0 | 0.9 | CSTB | Th-U édition 2007 |
| Acoustic insulation | 27 dBA | | 27 dBA | | CFI Andersay | ISO140-4 |
| Fire classification* | B-s1, d0 | | | | LNE | En 13501-1:2002 |
| Impact M50/1200 j* | pass | | | | SOCOTEC- France | |
| Controlite® + DP 16 clear | | | | | Danpal | ASHREA STANDARD 74-1988 |
| Light transmission | 37% | 5% | 37% | 5% | | |
| SHGC | 0.40 | 0.18 | 0.40 | 0.18 | | |
| Controlite® + DP 16 clear SOFTLITE | | | | | | |
| Light transmission | 25% | 5% | 25% | 5% | | |
| SHGC | 0.35 | 0.17 | 0.35 | 0.17 | | |
| Free span between supports (for 100Kg /sqm load 2 support. Sf 1.5) | 4.8M | | 3.2M | | | |
| Maximum panel length | 11.98M | | | | | |
| 10 years warranty | Yes | | | | | |

Controlite® delivers a variable shading coefficient by changing its solar transmission properties to give architects and designers unlimited flexibility in the design of daylighting solutions.

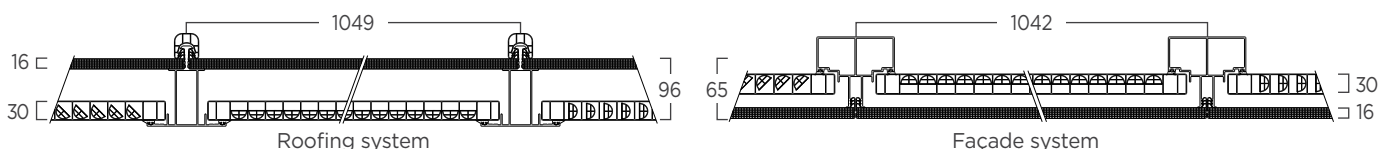

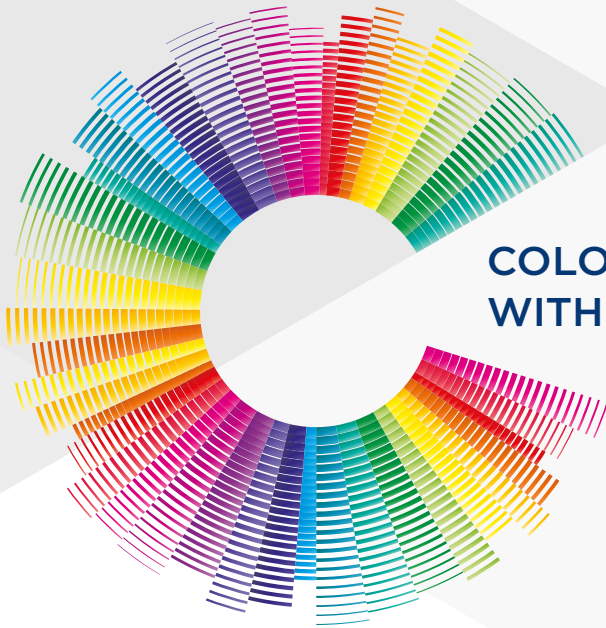

COLOUR YOUR ATMOSPHERE WITH THE DANPAL® PALETTE

ABOUT THE COMPANY

Innovative light architecture systems for building envelopes

Danpal® are creators of exceptional light-transmitting architectural systems for building envelopes, providing optimal solar and thermal comfort.

For 50 years, our innovative systems have helped architects to transform light (both natural and artificial) into a powerful and versatile tool, for architectural creations that are internally and externally radiant.

An industry visionary, Danpal® are originators of the Danpalon® translucent panel standing seam system - a light architecture solution used around the world in commercial, education, transport, health, sports and high-tech projects.

Today, the company offers complete systems - providing total solutions for the building envelope. Danpal® designs, manufactures and distributes an unmatched range of daylighting systems for all types of building requirements - from Façades, cladding, roofs, skylights, shading, to interior and outdoor applications.

Danpal® systems are built around innovative technologies, deep architectural know-how and the ever evolving needs of our clients. Operating in five continents, Danpal® inspires architectural creativity with its rainbow of light architecture solutions.

Controlite® is an integral part of Danpal's range of systems - giving you a complete solution



FAÇADE



CLADDING



SKYLIGHT



OUTDOOR



SHADING



INTERIOR